

# CAGGIATI

## INOX

### ROTARY SPRAY HEADS

### SFERE DI LAVAGGIO ROTANTI

BALL DIAMETER  
DIAMETRO SFERA

64

EXTERNAL PIPE DIAMETER  
DIAMETRO TUBO ESTERNO

EXTERNAL PIPE DIAMETER DIAMETRO TUBO ESTERNO						
64	33,7	35	38,1	40	48,3	50,8

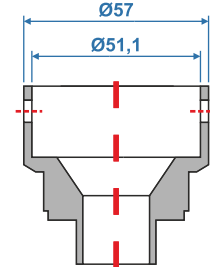
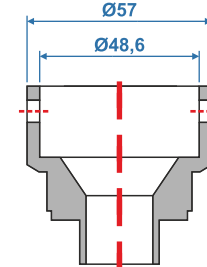
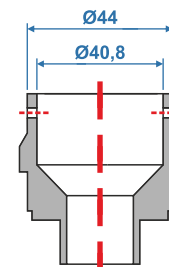
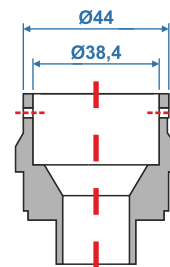
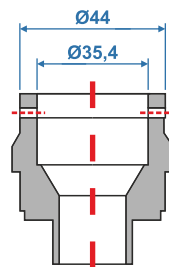
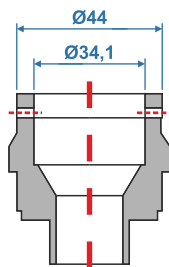
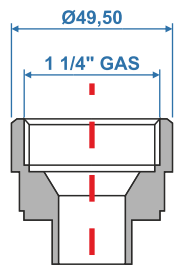

180°L

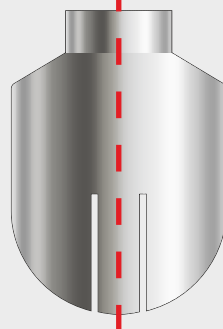

360°

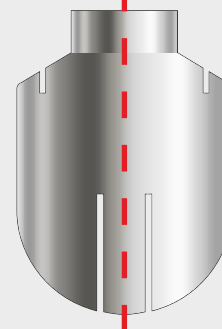

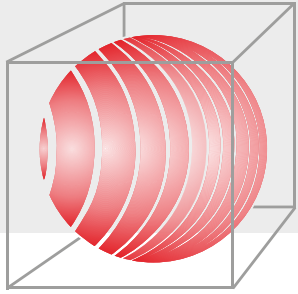

# CAGGIATI

## INOX

### ROTARY SPRAY HEADS

### SFERE DI LAVAGGIO ROTANTI

BALL DIAMETER  
DIAMETRO SFERA

44

EXTERNAL PIPE DIAMETER DIAMETRO TUBO ESTERNO							
19	21,3	25,4	28	33,7	35	38,1	40

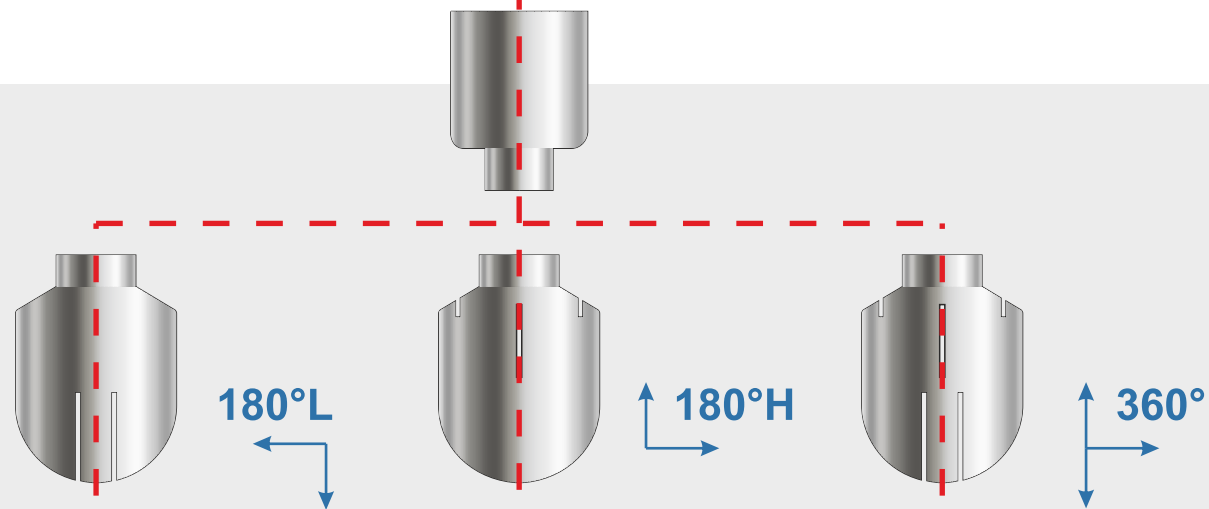
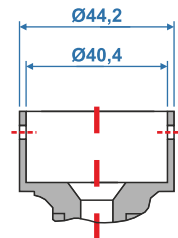
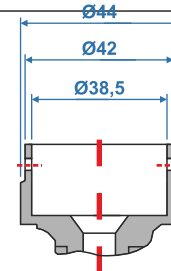
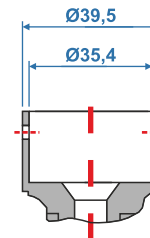
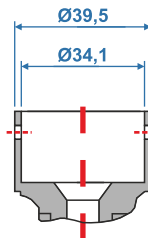
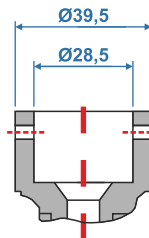
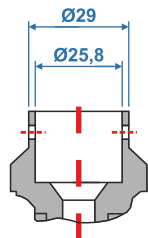
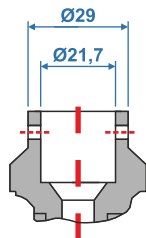
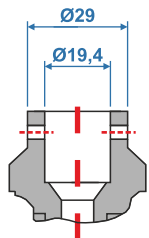

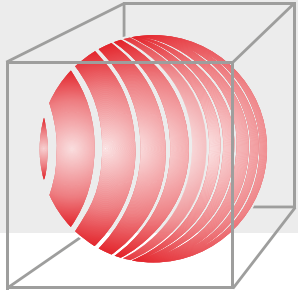

# CAGGIATI INOX

## ROTARY SPRAY HEADS SFERE DI LAVAGGIO ROTANTI

BALL DIAMETER  
DIAMETRO SFERA

24

EXTERNAL PIPE DIAMETER  
DIAMETRO TUBO ESTERNO

EXTERNAL PIPE DIAMETER DIAMETRO TUBO ESTERNO						
12,7	18	19,1	21,3	1/2" GAS	3/8"GAS	1/2"GAS

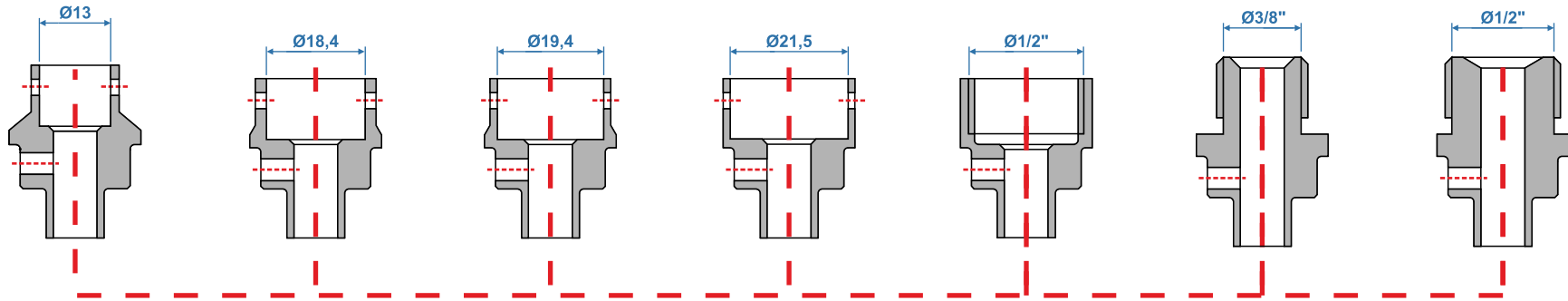

180°L

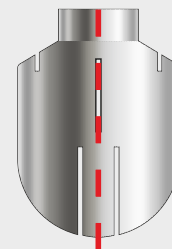
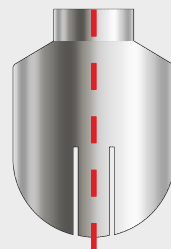

360°